

Indoor Flush Mounted-Surface Mounted Distribution Enclosure and Two-Three Purpose Enclosures

- IP40 Wall Type Flush Mounted W. Automate Distribution Enclosures



218

- IP40 Wall Type Surface Mounted W. Automate Distribution Enclosures with Glass Cover



222

- IP20 Wall Type Flush Mounted W. Automate Distribution Enclosures



226

- IP20 Wall Type Flush Mounted W. Automat Distribution Enclosures with Glass Cover



230

- IP20 Wall Type Flush Mounted W. Automate and Assembly Plate Distribution Enclosures



234

-
- Indoor Combined Enclosures IP20



235

-
- IP40 Wall Type Surface Mounted W. Automate and Assembly Plate Distribution Enclosures



236

-
- IP40 Wall Type Double Purpose Distribution Compensation Enclosures



238

-
- Surface Mounted X5 Boiler Counter Enclosures

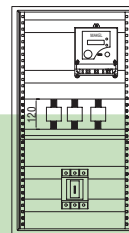

240

-
- Wall Type Distribution and Compensation Enclosures



241

-
- Wall Type Triple Purpose Distribution Compensation and Counter Enclosures



242

W.Automate Distribution Enclosures IP40

Wall Type Surface
Mounted



Raw Material and Materials

Sheet : Galvanized sheet
Paint : RAL 7035 Epoxy Polyester
Body : 1.0 mm Monobloc painted

Cover : 1.0 mm painted
Internal Assembly Plinth : 1.0 mm-1.2 m
Bottom-Top Plates : 1.2 mm painted

Specifications and Intended Purpose

- Monobloc body structure ensuring IP40 protection level
- For fuse distribution
- Internal components are standard and dismantable
- Contact hazard protection sheets are with teeth and hinge, easily dismantable
- Special design assembly screw with spring is used as handle
- Protection brush with hair length of 30 mm for cable exit

Area of Use

- Indoor, dry areas
- Small workshops-stores and shops

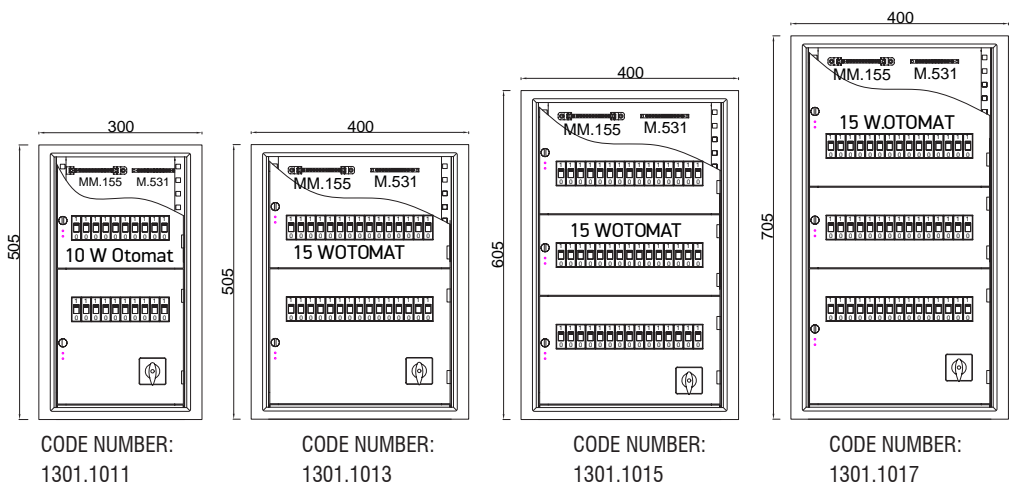

W. Automate Distribution Enclosures IP40

Wall Type Surface Mounted

LIST NO	PRODUCT CODE	NUMBER OF W.AUTOMATE	PACCO TPS	TERMINAL PLACE	BUSBAR		SIZES WxLxD
					NEUTRAL	GROUND	
1	1301.1011	20	PACCO	NO	11+1	11+1	300x505x170
2	1301.1013	30	PACCO	NO	11+1	11+1	400x505x170
3	1301.1015	45	PACCO	NO	11+1	11+1	400x605x170
4	1301.1017	45	PACCO	NO	11+1	11+1	400x705x170
5	1301.1019	60	TPS	NO	19+1	19+1	400x905x170
6	1301.1021	63	TPS	NO	19+1	19+1	500x805x170
7	1301.1023	63	PACCO	NO	19+1	11+1	500x705x170

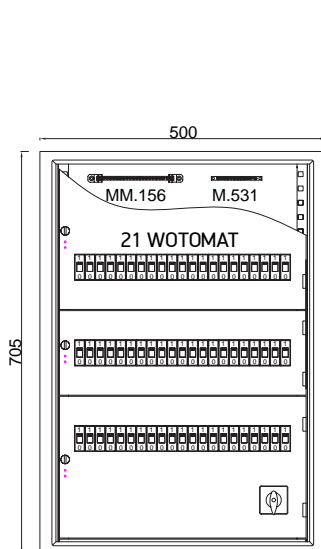

CODE NUMBER:
1301.1019

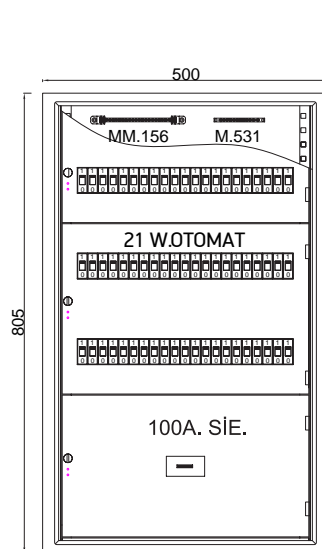

CODE NUMBER:
1301.1021

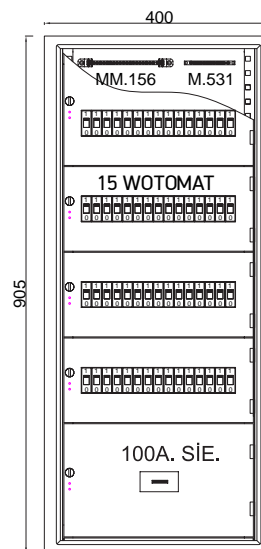

CODE NUMBER:
1301.1023

- 3400.1207

- 3400.1291

- 3400.1313

- 2210.0093

- 4000.3341 | 4000.2283

- 4000.3423

M5x10 GUIDE
- 4000.3265

4000.3185
- 4000.3261

4000.2185
- 4000.2125

4000.3221
- 4000.3427

4000.2345 | 4000.3185
- 3300.1225

4000.2264
- 4000.3271

3300.1221
- 4000.2264

4000.3211

W. Automate Distribution Enclosures IP40
Wall Type Surface Mounted

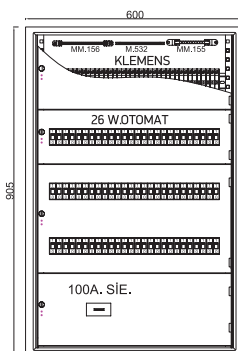
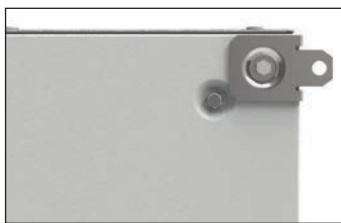
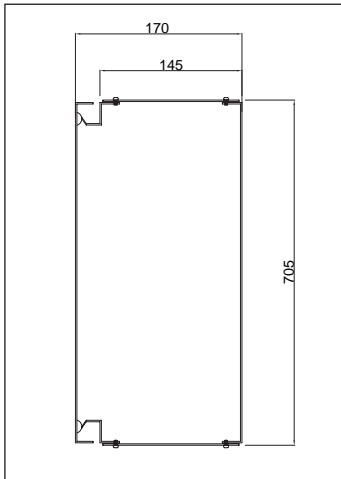
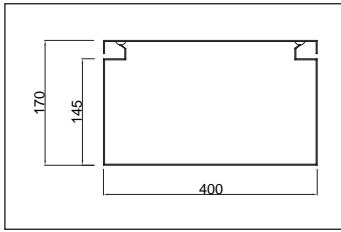

CODE NUMBER:
1301.1025

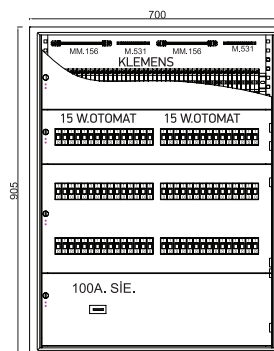

CODE NUMBER:
1301.1027

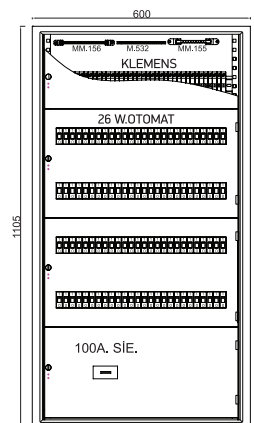

CODE NUMBER:
1301.1029

W. Automate Distribution Enclosures IP40

Wall Type Surface Mounted

LIST NO	PRODUCT CODE	NUMBER OF W.AUTOMATE	PACCO TPS	TERMINAL PLACE	BUSBAR		SIZES WxLxD
					NEUTRAL	GROUND	
1	1301.1025	78	TPS	EXITS	30+2	19+1	600x905x220
2	1301.1027	90	TPS	EXITS	38+2	22+2	700x905x220
3	1301.1029	104	TPS	EXITS	30+2	19+1	600x1105x220
4	1301.1031	120	TPS	EXITS	38+2	22+2	700x1105x220
5	1301.1033	150	TPS	EXITS	38+2	22+2	700x1305x220

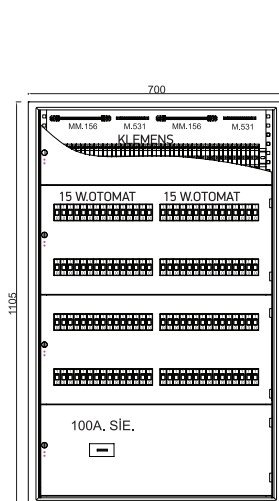

CODE NUMBER:
1301.1031

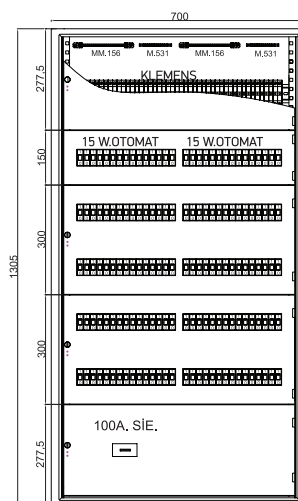

CODE NUMBER:
1301.1033

- 3400.1207



3400.1291
- 3400.1313

- 2210.0093



4000.3341 | 4000.2283
- 4000.3423



M5x10 KILAVUZ
- 4000.2125



4000.3221
- 4000.3261



4000.2185
- 4000.3427



4000.2345 | 4000.3185
- 4000.3265



4000.3185
- 3300.1225



4000.2264
- 4000.3271

- 3300.1223



4000.2264
- 4000.3211



W.Automate Distribution Enclosures with Glass Cover IP40

Wall Type Surface
Mounted

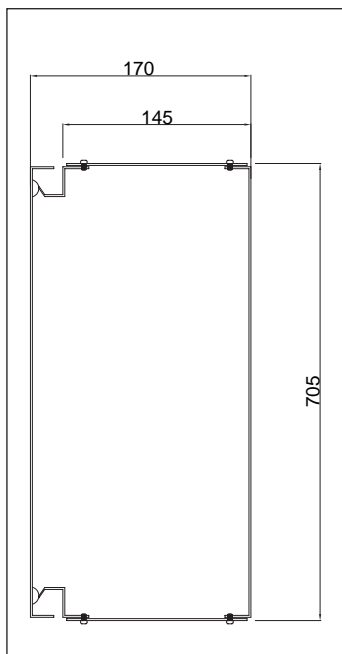
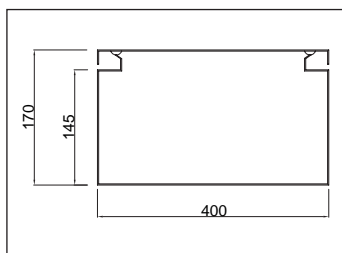

Raw Material and Materials

Sheet : Galvanized sheet
 Paint : RAL 7035 Epoxy Polyester
 Body : 1.0 mm Monobloc painted
 Glass : 4 mm tempered flat glass

Cover : 1.0 mm painted
 Internal Assembly Plinth : 1.0 mm-1.2 m
 Bottom-Top Plates : 1.2 mm painted
 Glass Assemble : Polyurethane Fermadur

Specifications and Intended Purpose

- Monobloc body structure ensuring IP40 protection level
- For fuse distribution
- Internal components are standard and dismantable
- Contact hazard protection sheets are with teeth and hinge, easily dismantable
- Special design assembly screw with spring is used as handle
- Protection brush with hair length of 30 mm for cable exit
- Glass holding teeth for replacement in case of broken glass

Area of Use

- Indoor, dry areas
- Small workshops-stores and shops

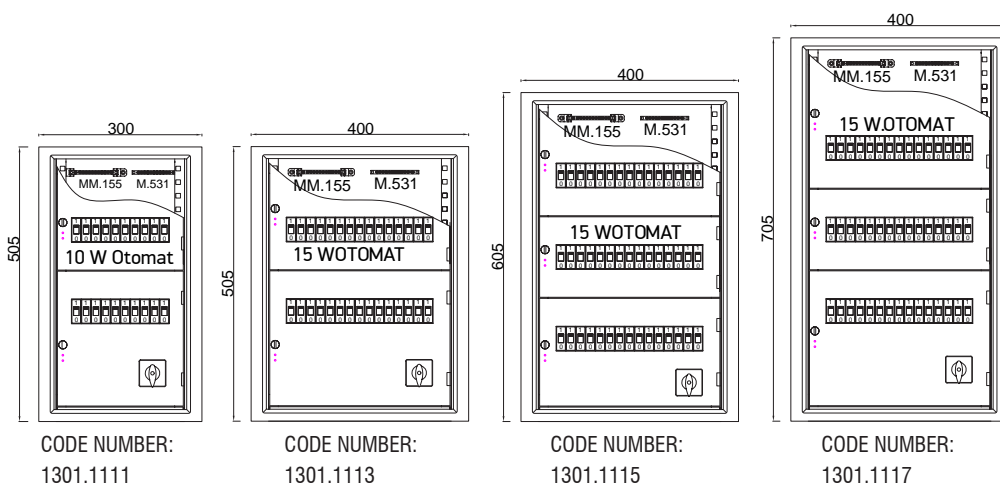

W. Automate Distribution Enclosures with Distribution Enclosures IP40
Wall Type Surface Mounted

LIST NO	PRODUCT CODE	NUMBER OF W.AUTOMATE	PACCO TPS	TERMINAL PLACE	BUSBAR		SIZES WxLxD
					NEUTRAL	GROUND	
1	1301.1111	20	PACCO	NO	11+1	11+1	300x505x170
2	1301.1113	30	PACCO	NO	11+1	11+1	400x505x170
3	1301.1115	45	PACCO	NO	11+1	11+1	400x605x170
4	1301.1117	45	PACCO	NO	11+1	11+1	400x705x170
5	1301.1119	63	PACCO	NO	19+1	11+1	500x705x170
6	1301.1121	63	TPS	NO	19+1	19+1	500x805x170
7	1301.1123	60	TPS	NO	19+1	19+1	400x905x170

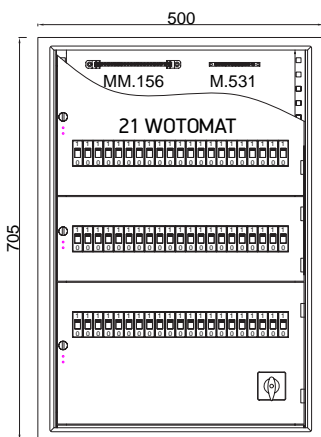
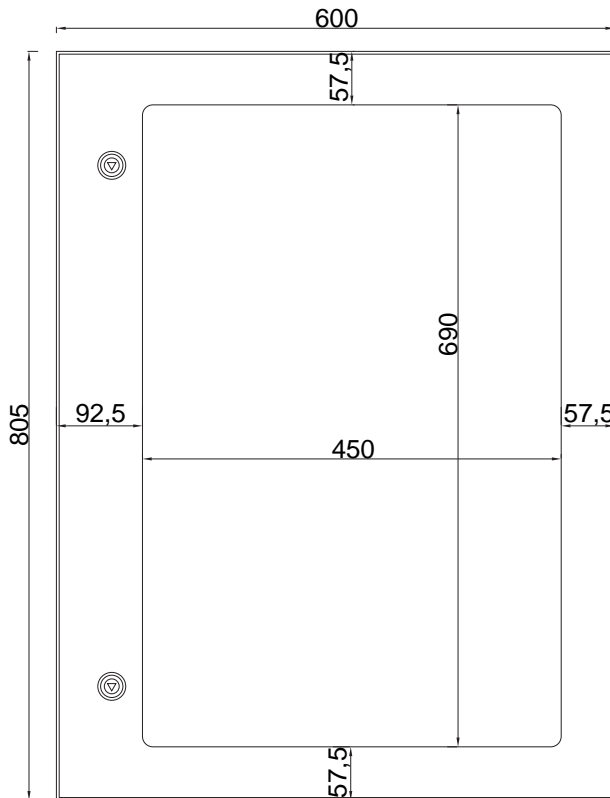

CODE NUMBER:
1301.1119

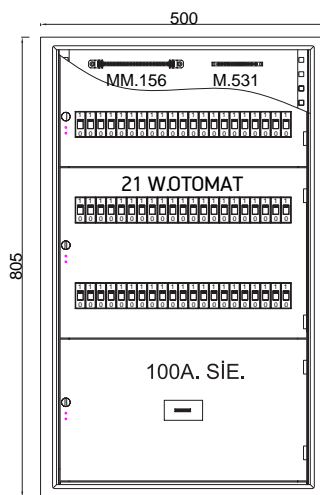

CODE NUMBER:
1301.1121

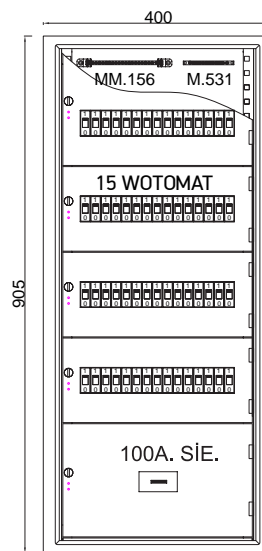

CODE NUMBER:
1301.1123



W. Automate Distribution Enclosures with Distribution Enclosures IP40
Wall Type Surface Mounted

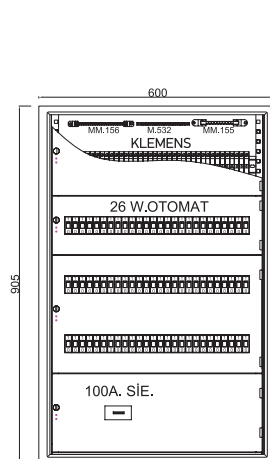

CODE NUMBER:
1301.1125

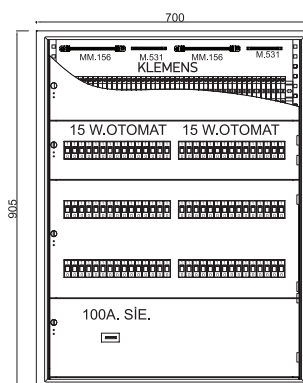

CODE NUMBER:
1301.1127

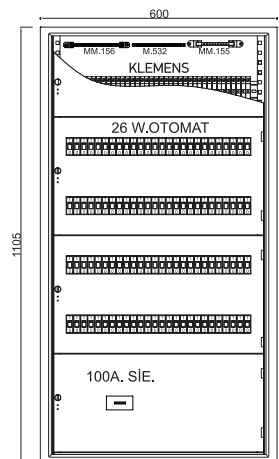

CODE NUMBER:
1301.1129

W. Automate Distribution Enclosures with Distribution Enclosures IP40
Wall Type Surface Mounted

LIST NO	PRODUCT CODE	NUMBER OF W.AUTOMATE	PACCO TPS	TERMINAL PLACE	BUSBAR		SIZES WxLxD
					NEUTRAL	GROUND	
1	1301.1125	78	TPS	EXITS	30+2	19+1	600x905x220
2	1301.1127	90	TPS	EXITS	38+2	22+2	700x905x220
3	1301.1129	104	TPS	EXITS	30+2	19+1	600x1105x220
4	1301.1131	120	TPS	EXITS	38+2	22+2	700x1105x220
5	1301.1133	150	TPS	EXITS	38+2	22+2	700x1305x220

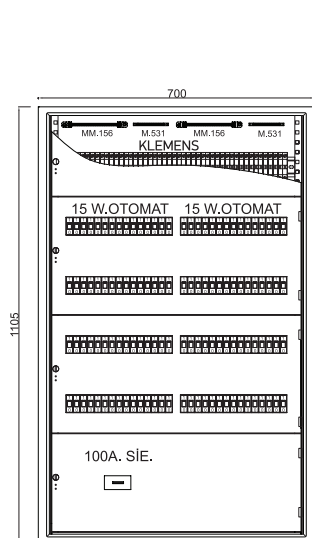
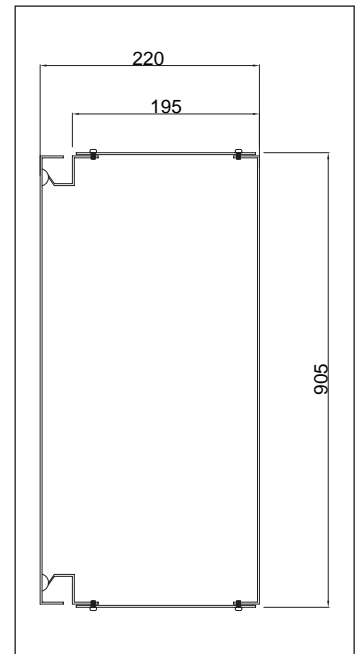
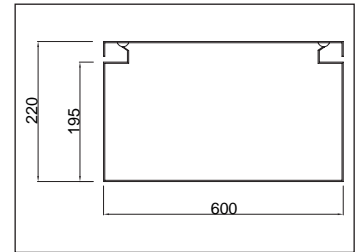

CODE NUMBER:
1301.1131

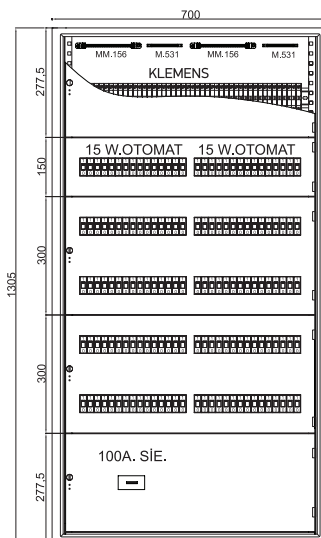

CODE NUMBER:
1301.1133

W.Automate Distribution Enclosures IP20 Wall Type Surface Mounted

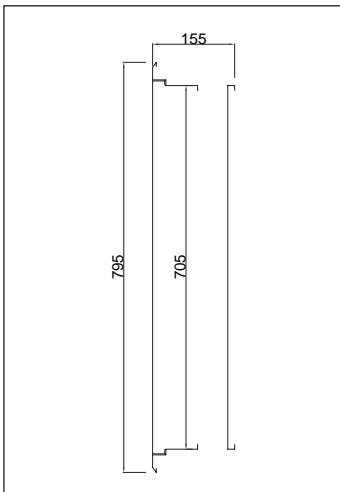
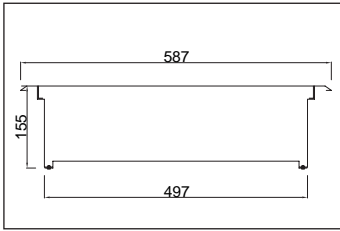
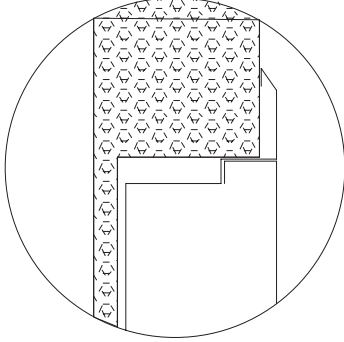

Raw Material and Materials

Sheet	: Galvanized sheet
Paint	: RAL 7035 Epoxy Polyester
Body	: 1.0 mm Monobloc; painted
Cover	: 1.0 mm embedded

Internal Assembly	: 1.0 mm-1.2 mm
Plinth	: Backflap hinge 40x40 mm (zamak)
Hinge	: Painted (without seal)

Specifications and Intended Purpose

- Encastered body structure ensuring IP40 protection level
- For fuse distribution
- Internal components are standard and dismantable
- Contact hazard protection sheets are with teeth and hinge, easily dismantable
- Special design assembly screw with spring is used as handle
- Open bottom and top for cable entry-exit

Area of Use

- Indoor, dry areas
- Small workshops-stores and shops
- Duvara gömülü montajlanır.

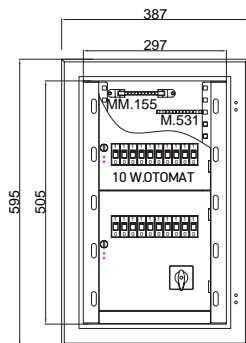

CODE NUMBER:
1302.1011

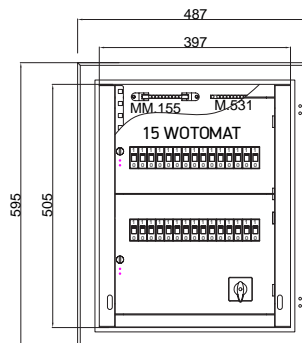

CODE NUMBER:
1302.1013

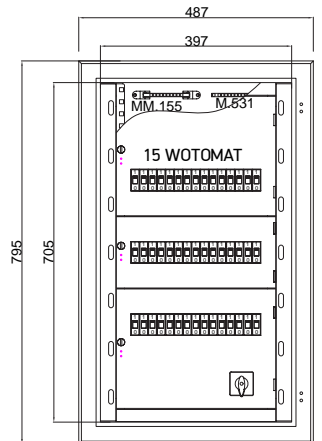

CODE NUMBER:
1302.1015

W. Automate Distribution Enclosures IP20

Wall Type Flush Mounted

LIST NO	PRODUCT CODE	NUMBER OF W.AUTOMATE	PACCO TPS	TERMINAL PLACE	BUSBAR		OUTSIDE CASING SIZE	NET INTERNAL SIZE
					NEUTRAL	GROUND		
1	1302.1011	20	PACCO	NO	11+1	11+1	387x595x155	297x505x142
2	1302.1013	30	PACCO	NO	11+1	11+1	487x595x155	397x505x142
3	1302.1015	45	PACCO	NO	11+1	11+1	487x795x155	397x705x142
4	1302.1017	63	TPS	NO	19+1	11+1	587x795x155	497x705x142
5	1302.1019	60	TPS	NO	19+1	11+1	487x995x155	397x905x142

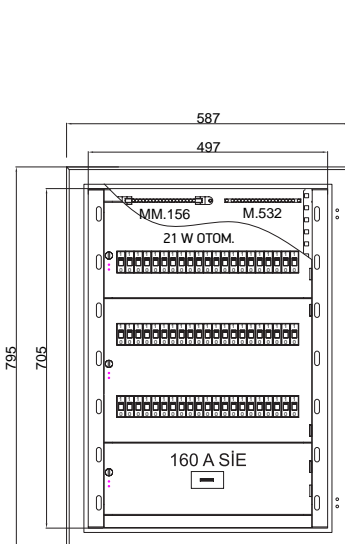
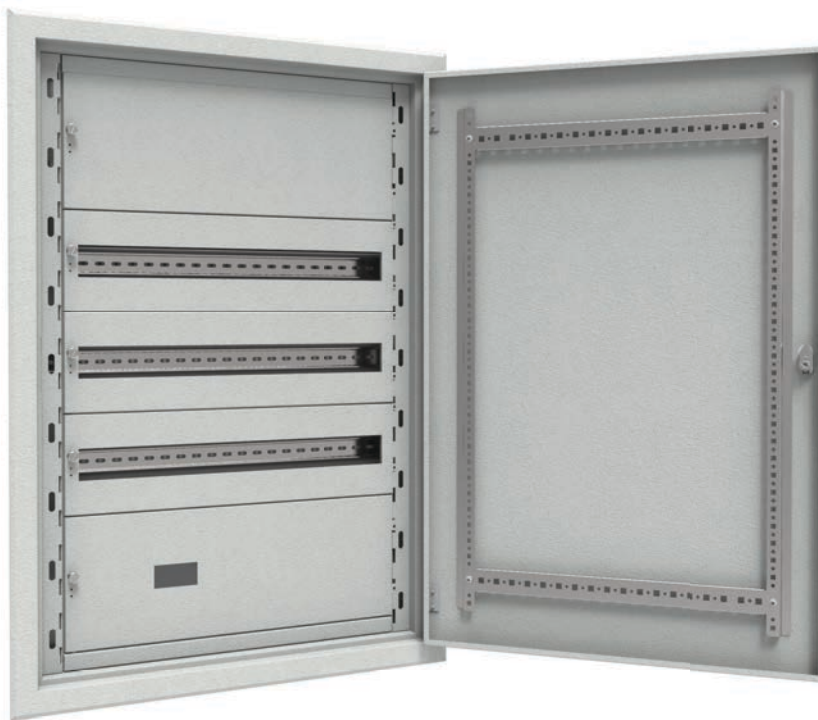

CODE NUMBER:
1302.1017

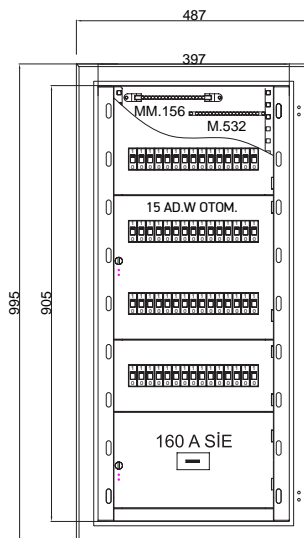

CODE NUMBER:
1302.1019

- 3400.1207

- 3400.1291

- 3400.1211

- 3400.1441

- 4000.3273 4000.3401
2210.0091

- 4000.3407
4000.2125

- 4000.3221

- 4000.3423

- 4000.3341

- 4000.3185
4000.3265

- 4000.3185
4000.3261

- 4000.2185
4000.3427

- 4000.2345 4000.3185
3300.1221

- 4000.2264

- 4000.3211
3300.1225

- 4000.2264

- 4000.3271

W. Automate Distribution Enclosures IP20
Wall Type Flush Mounted

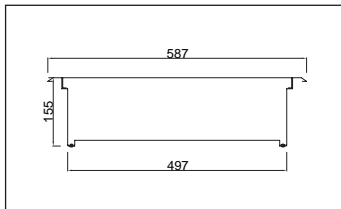
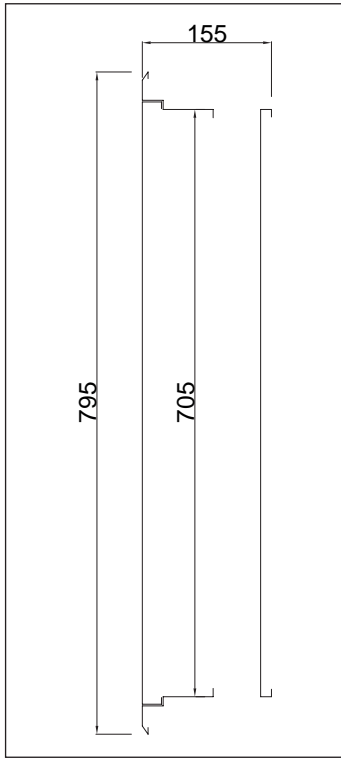

Flush Mounted Enclosure Top View Ground Neutral Busbar

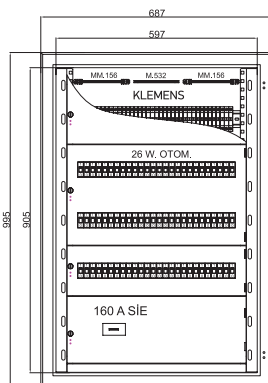

CODE NUMBER:
1302.1021

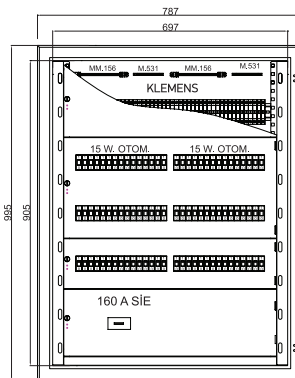

CODE NUMBER:
1302.1023

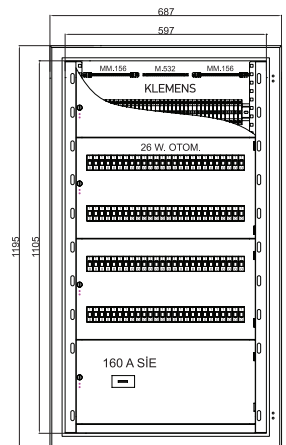

CODE NUMBER:
1302.1025

W. Automate Distribution Enclosures IP20 Wall Type Flush Mounted

LIST NO	PRODUCT CODE	NUMBER OF W.AUTOMATE	PACCO TPS	TERMINAL PLACE	BUSBAR		OUTSIDE CASING SIZE	NET INTERNAL SIZE
					NEUTRAL	GROUND		
1	1302.1021	78	TPS	EXITS	30+2	11+1	687x995x155	597x905x142
2	1302.1023	90	TPS	EXITS	38+2	22+2	787x995x155	697x905x142
3	1302.1025	104	TPS	EXITS	38+2	19+1	687x1195x155	597x1105x142
4	1302.1027	120	TPS	EXITS	38+2	22+2	787x1195x155	697x1105x142
5	1302.1029	150	TPS	EXITS	38+2	22+2	787x1395x155	697x1305x142

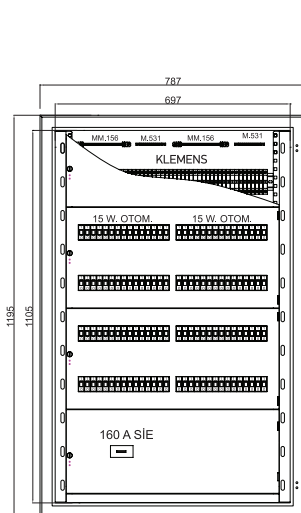

CODE NUMBER:
1302.1027

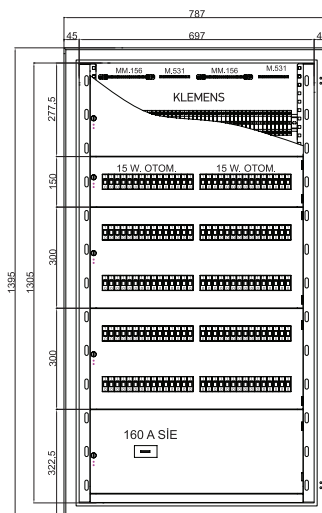

CODE NUMBER:
1302.1029

W.Automate Distribution Enclosures with Glass Cover IP20

Wall Type Flush
Mounted

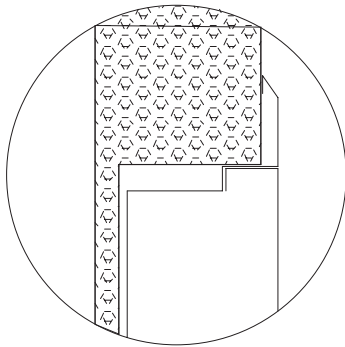

Raw Material and Materials

Sheet : Galvanized sheet
 Paint : RAL 7035 Epoxy Polyester
 Body : 1.0 mm encastered painted
 Glass : 4 mm tempered flat glass

Cover : 1.0 mm painted embedded
 (without seal)
 Internal Assembly : 1.0 mm-1.2 m
 Plinths : Backflap hinge 40x40 mm
 Hinge : (zamak)

Specifications and Intended Purpose

- For fuse distribution
- Internal components are standard and dismantable
- Contact hazard protection sheets are with teeth and hinge, easily dis mountable
- Special design assembly screw with spring is used as handle
- Protection brush with hair length of 30 mm for cable exit
- Glass holding teeth for replacement in case of broken glass

Area of Use

- Indoor, dry areas
- Mounted as wall embedded
- Small workshops-stores and shops

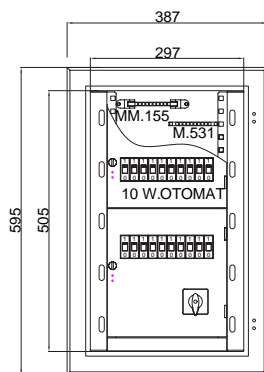

CODE NUMBER:
1302.2111

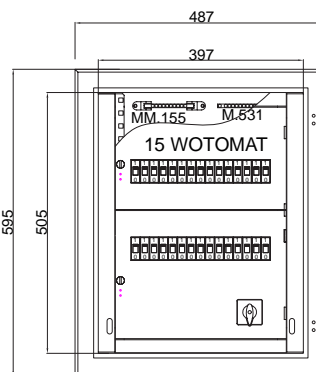

CODE NUMBER:
1302.2113

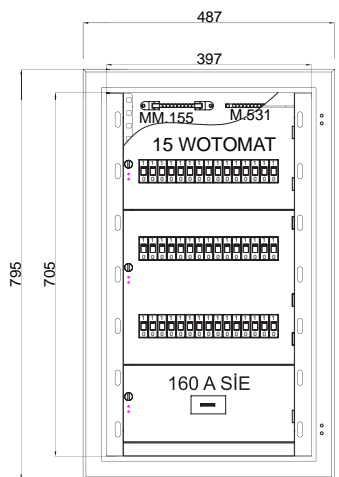

CODE NUMBER:
1302.2115

W. Automate Distribution Enclosures with Glass Cover IP20 Wall Type Flush Mounted

LIST NO	PRODUCT CODE	NUMBER OF W.AUTOMATE	PACCO TPS	TERMINAL PLACE	BUSBAR		OUTSIDE CASING SIZE	NET INTERNAL SIZE
					NEUTRAL	GROUND		
1	1302.2111	20	PACCO	NO	11+1	11+1	387x595x155	297x505x142
2	1302.2113	30	PACCO	NO	11+1	11+1	487x595x155	397x505x142
3	1302.2115	45	TPS	NO	11+1	11+1	487x795x155	397x705x142
4	1302.2117	63	TPS	NO	19+1	11+1	587x795x155	497x705x142
5	1302.2119	60	TPS	NO	19+1	11+1	487x995x155	397x905x142

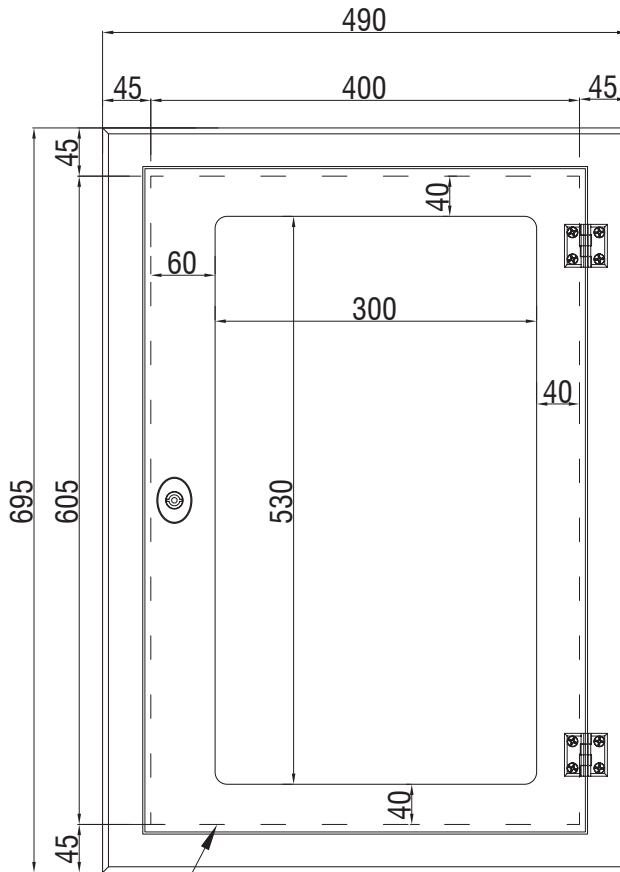

Section used beneath the flush mounted enclosure

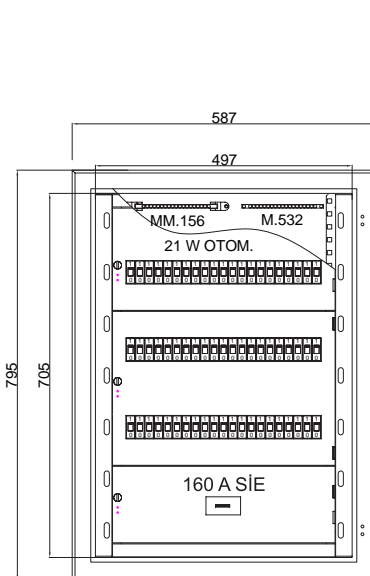

CODE NUMBER:
1302.2117

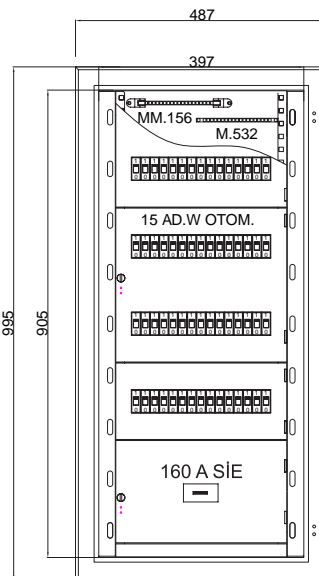

CODE NUMBER:
1302.2119

- 3400.1207
- 3400.1291
- 3400.1211
- 3400.1441
- 4000.3273 4000.3401 2210.0091
- 4000.3407
- 2210.0085
- 4000.2345 4000.3185
- 4000.3341
- 4000.3185
- 4000.3423
- 4000.2125
- 4000.3221
- 4000.3427
- 4000.2345 4000.3185
- 3300.1223
- 4000.2264
- 4000.3211
- 3300.1225
- 4000.2264
- 4000.3271

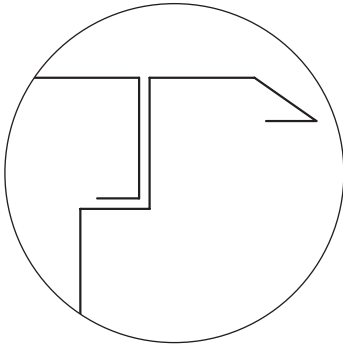

**W. Automate Distribution Enclosures with Glass Cover IP20
Wall Type Flush Mounted**

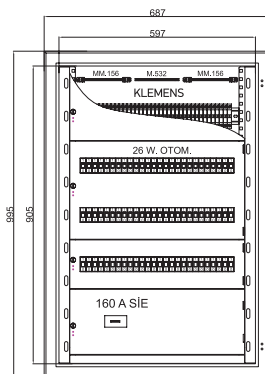

CODE NUMBER:
1302.2121

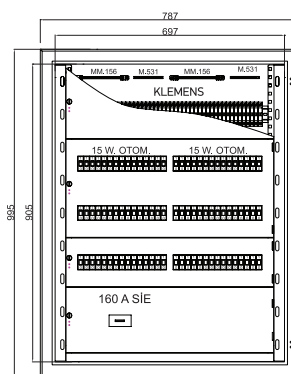

CODE NUMBER:
1302.2123

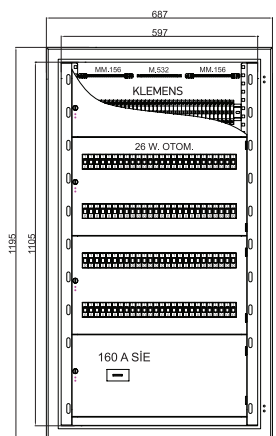

CODE NUMBER:
1302.2125

**W. Automate Distribution Enclosures with Glass Cover IP20
Wall Type Flush Mounted**

LIST NO	PRODUCT CODE	NUMBER OF W.AUTOMATE	PACCO TPS	TERMINAL PLACE	BUSBAR		OUTSIDE CASING SIZE	NET INTERNAL SIZE
					NEUTRAL	GROUND		
1	1302.2121	78	TPS	EXITS	30+2	11+1	687x995x155	597x905x142
2	1302.2123	90	TPS	EXITS	38+2	22+2	787x995x155	697x905x142
3	1302.2125	104	TPS	EXITS	38+2	19+1	687x1195x155	597x1105x142
4	1302.2127	120	TPS	EXITS	38+2	22+2	787x1195x155	697x1105x142
5	1302.2129	150	EXITS	38+2	22+2	787x1395x155	697x1305x142	

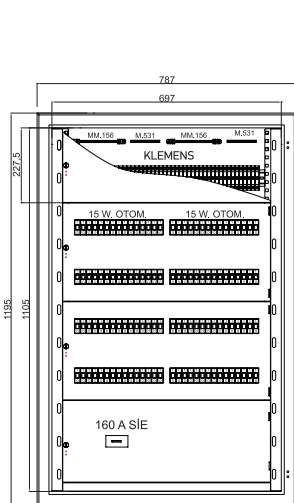
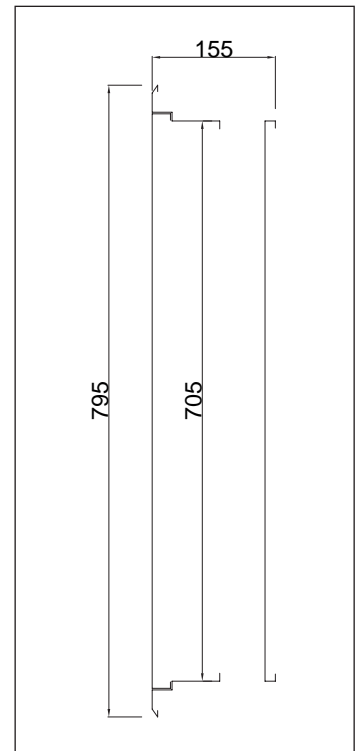
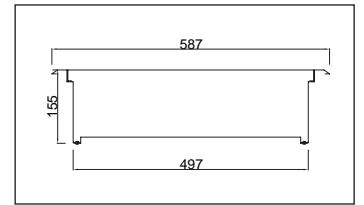
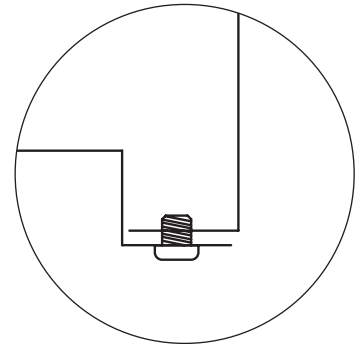

CODE NUMBER:
1302.2127

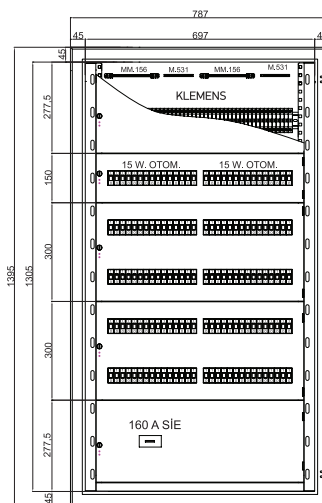

CODE NUMBER:
1302.2129

